

UM10468

SSL2108X buck evaluation board

Rev. 1 — 30 August 2011

User manual

Document information

Info	Content
Keywords	SSL2108X, Buck, down converter, AC/DC converter, retrofit SSL, LED driver, LED retrofit lamp, non-dimmable
Abstract	<p>The SSL2108X is a range of high-voltage Integrated Circuits (ICs), intended to drive non-dimmable retrofit LED lamps in general lighting applications. This document describes the evaluation board for mains operated non-dimmable LED drivers using the SSL21081, SSL21082, SSL21083 and SSL21084 controller ICs.</p> <p>Refer to the SSL2108X data sheet for details on the SSL2108X device and application note AN11041 for general application information.</p>



Revision history

Rev	Date	Description
v.1	20110830	first issue

Contact information

For more information, please visit: <http://www.nxp.com>

For sales office addresses, please send an email to: salesaddresses@nxp.com

1. Introduction

WARNING

Lethal voltage and fire ignition hazard



The non-insulated high voltages that are present when operating this product, constitute a risk of electric shock, personal injury, death and/or ignition of fire.

This product is intended for evaluation purposes only. It shall be operated in a designated test area by personnel qualified according to local requirements and labor laws to work with non-insulated mains voltages and high-voltage circuits. This product shall never be operated unattended.

The SSL2108X is a family of high-voltage Integrated Circuits (IC), designed to drive non-dimmable retrofit LED lamps in general lighting applications. The product family consists of four ICs with different configurations which are shown in [Table 1](#).

Table 1. SSL2108X type number overview

Type	Package	V _{mains} range (V (AC))	Internal MOSFET characteristics	Adjustable brownout protection
SSL21081	SO8	100 to 120	300 V; 2 Ω	no
SSL21082	SO12 ^[1]			yes
SSL21083	SO8	100 to 230	600 V; 5 Ω	no
SSL21084	SO12 ^[1]			yes

[1] SO12 package variants have more fused leads for lower thermal resistance and can be used when a higher output power is needed.

Main benefits of the product family are:

- Small Printed-Circuit Board (PCB) footprint providing a compact solution
- High-efficiency (up to 95 %)
- Ease of integration
- Low electronic Bill Of Material (BOM)

The SSL2108X provides accurate output control with more than 5 % LED current accuracy. The ICs can operate using Pulse-Width Modulation (PWM) dimming and have many protection features including easy external temperature feedback.

The SSL2108X driver family is the high performance solution for the next generation of retrofit LED lamps. These ICs provide a high efficiency, high-power factor solution in a small form factor.

Remark: Unless otherwise stated all voltages are in V (DC).

2. Safety warning

This reference board is connected to a high AC voltage (up to 250 V). Avoid touching the demo board during operation. An isolated housing is obligatory when used in uncontrolled, non-laboratory environments. Galvanic isolation of the mains phase using a fixed or variable transformer (Variac) is always recommended. These devices are recognized by the symbols shown in [Figure 1](#)

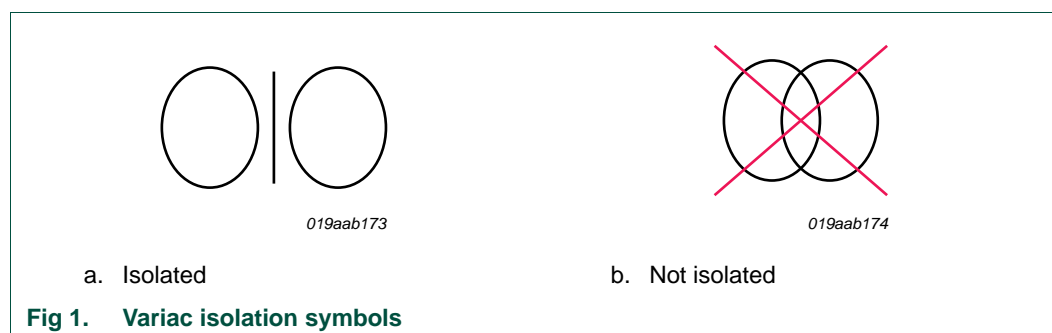

Fig 1. Variac isolation symbols

3. Specification

Table 2. Specifications for the reference board

Parameter	Value	Comment
AC line input voltage		
SSL21081 and SSL21082	85 V (AC) to 138 V (AC)	optimized for 100 V (AC)
SSL21083 and SSL21084	230 V (AC)	optimized for 100 V (AC)
Output voltage (V_{LED})		
SSL21081 and SSL21082	20 V to 70 V	optimized for 60 V
SSL21083 and SSL21084	20 V to 140 V	optimized for 120 V
Output current (I_{LED})		
SSL21081	95 mA, 70 mA, 38 mA	adjust using jumpers J7A, J8A, J9A
SSL21082	160 mA, 125 mA, 105 mA	adjust using jumpers J7A, J8A, J9A
SSL21083	55 mA, 35 mA, 18 mA	adjust using jumpers J7A, J8A, J9A
SSL21084	80 mA, 69 mA, 53 mA	adjust using jumpers J7A, J8A, J9A
Maximum LED output power ($P_{O(LED)}$)		
SSL21081 and SSL21083	6 W	optimized for 6 W using dedicated loads ^[1]
SSL21082 and SSL21084	15 W	optimized for 10 W using dedicated loads ^[1]
Switching frequency		
Nominal switching frequency ($f_{sw(nom)}$)	100 kHz	-
Board dimension (L × W × H)		
SSL21081, SSL21082, SSL21083 and SSL21084	70 mm × 60 mm × 23 mm	maximum footprint
Temperature		
Operating temperature	-40 °C to +100 °C	-

[1] Refer to [Section 5](#) for more detailed information.

4. Performance data

4.1 Output load

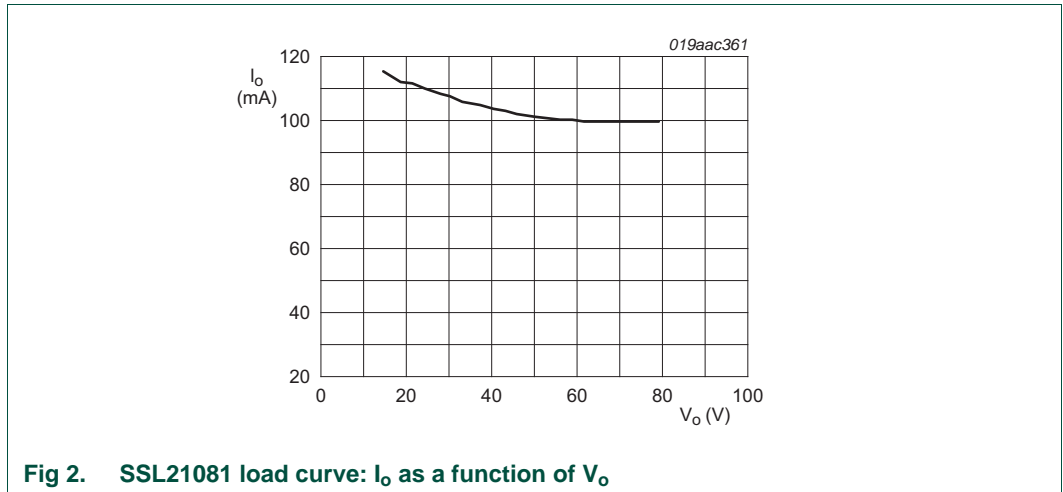

4.2 Efficiency Curve

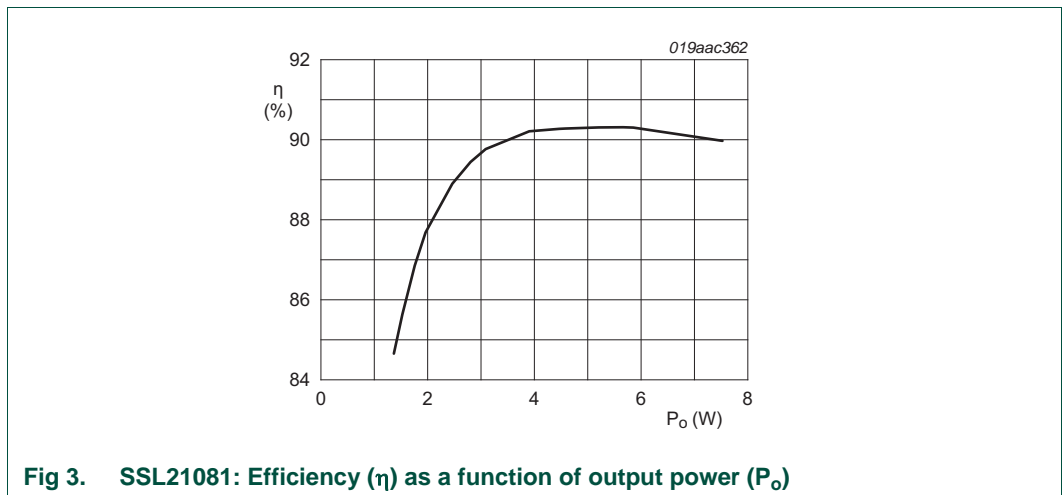

4.3 Input voltage dependency

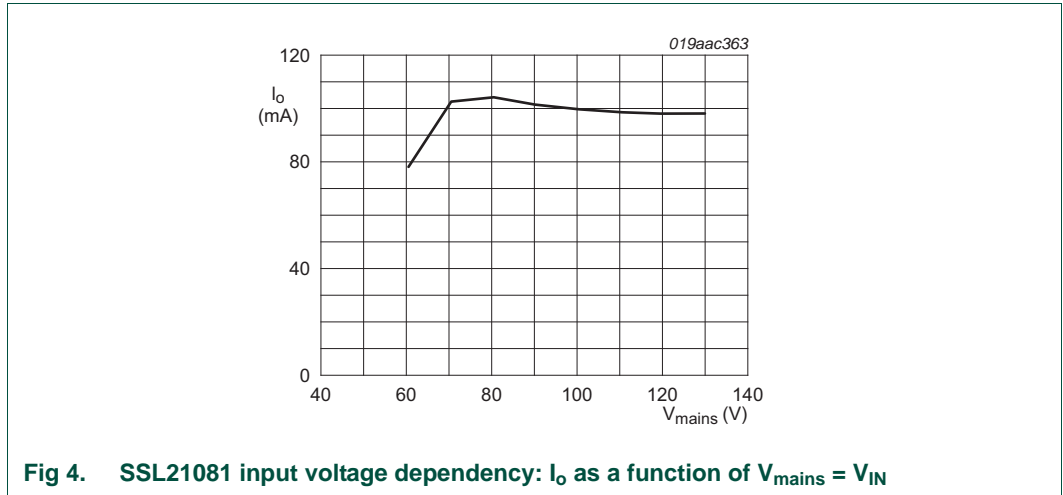

Fig 4. SSL21081 input voltage dependency: I_o as a function of V_{mains} = V_{IN}

4.4 ElectroMagnetic Compatibility data

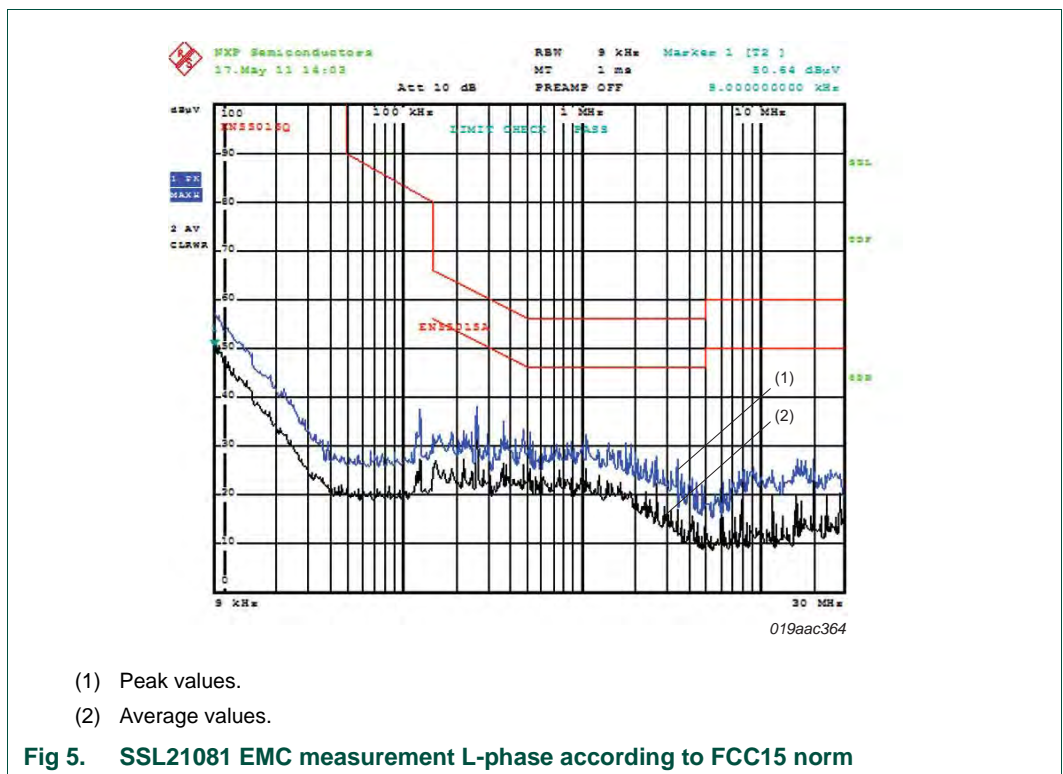
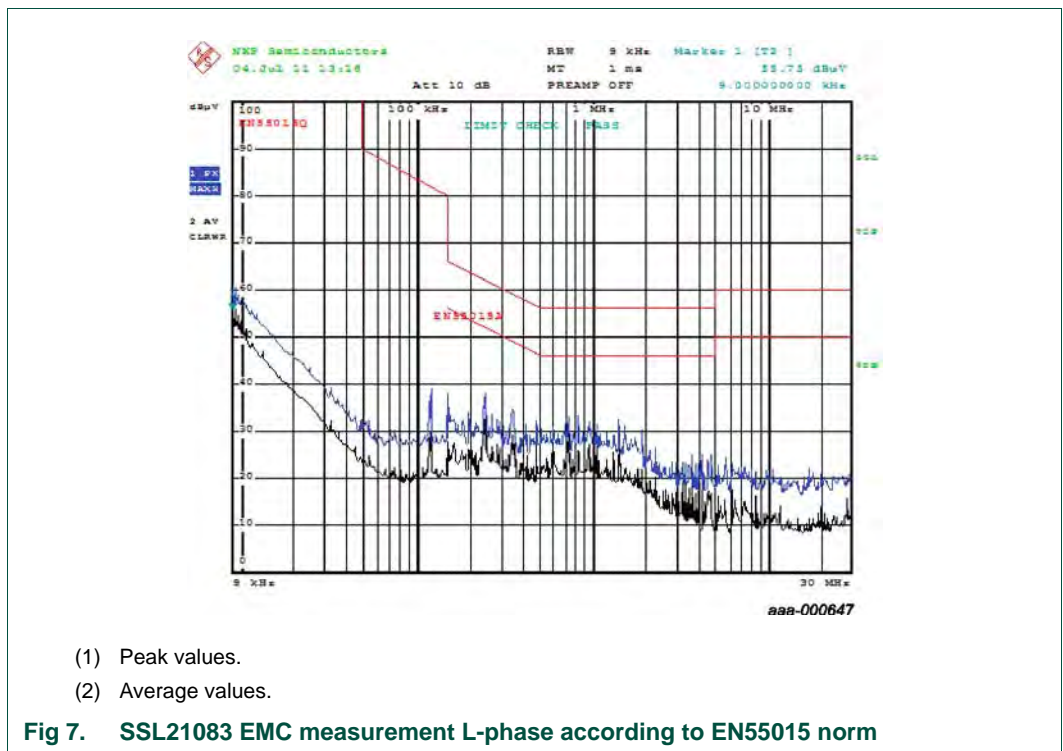
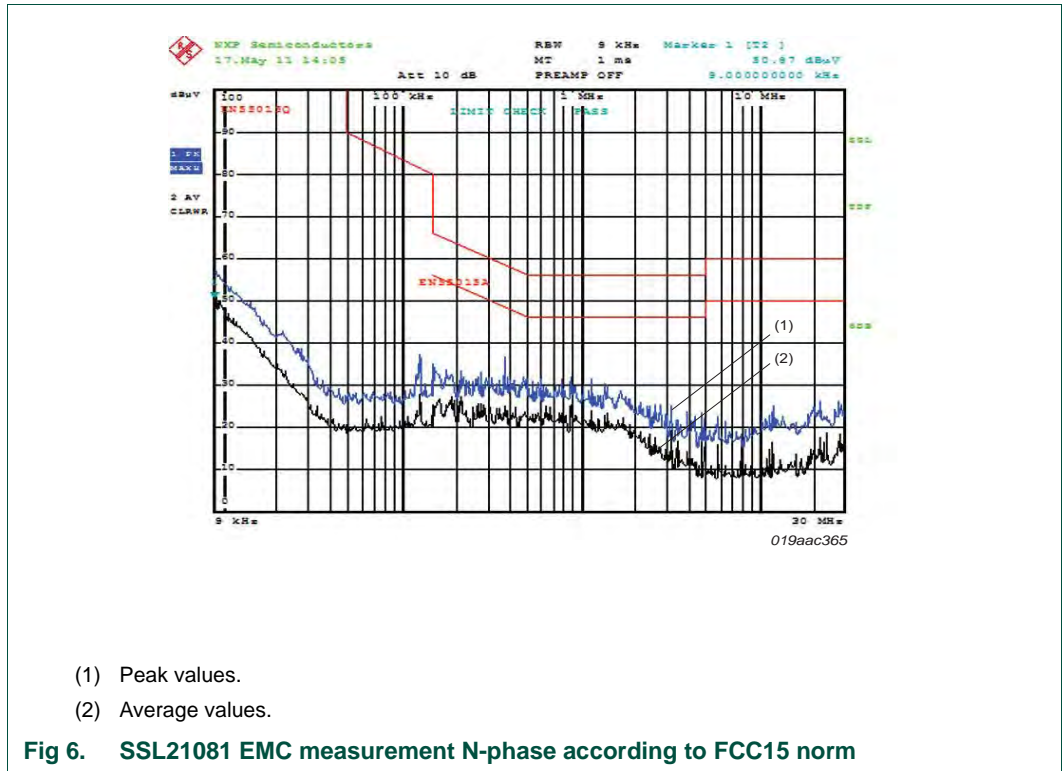
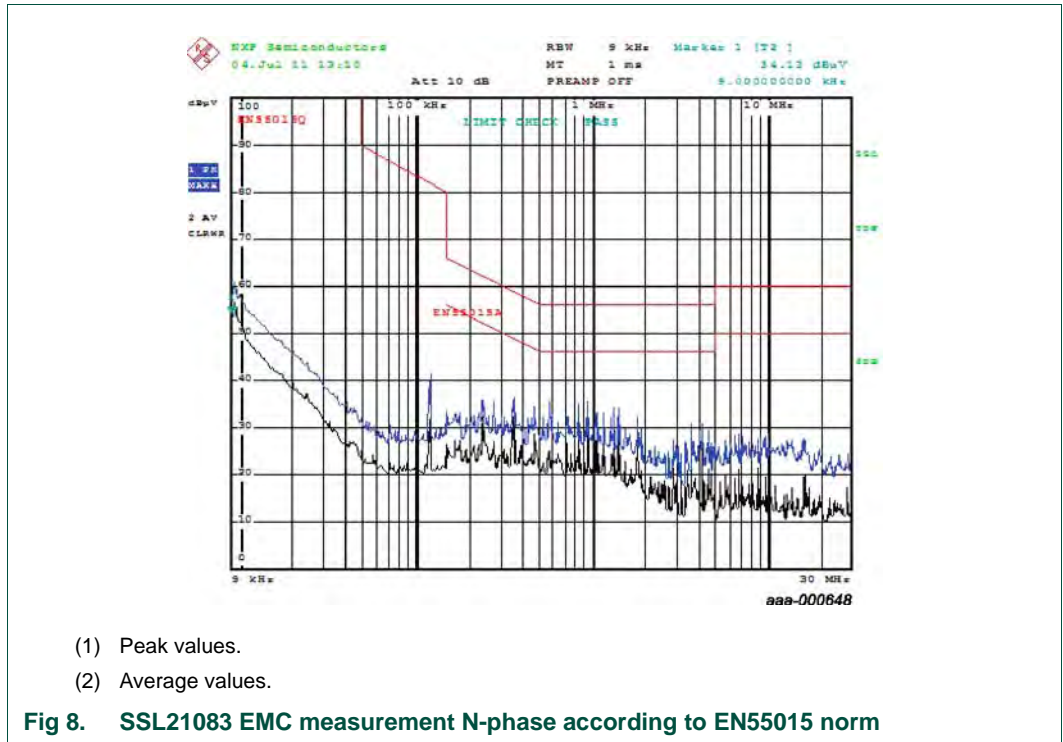

Fig 5. SSL21081 EMC measurement L-phase according to FCC15 norm





4.5 SSL21081 mains harmonics

Table 3. SSL21081 mains conducted harmonics

Line	Percent (%)	Class-C	Except	Line	Percent (%)	Class-C	Except
1	100	100	100	21	5.9	3	undefined
2	0	2	undefined	22	0	2	undefined
3	84.7	30	86	23	4.4	3	undefined
4	0	2	undefined	24	0.4	2	undefined
5	59.8	10	61	25	3.8	3	undefined
6	0	2	undefined	26	0.4	2	undefined
7	34.1	7	undefined	27	3.6	3	undefined
8	0	2	undefined	28	0	2	undefined
9	17.9	5	undefined	29	3.2	3	undefined
10	0	2	undefined	30	0	2	undefined
11	15.4	3	undefined	31	2.2	3	undefined
12	0	2	undefined	32	0.2	2	undefined
13	13.9	3	undefined	33	2.2	3	undefined
14	0	2	undefined	34	0.2	2	undefined
15	9.7	3	undefined	35	2	3	undefined
16	4.5	2	undefined	36	0.4	2	undefined
17	7	3	undefined	37	1.9	3	undefined
18	0.6	2	undefined	38	0	2	undefined
19	6.8	3	undefined	39	1.4	3	undefined
20	0.3	2	undefined	40	0	2	undefined

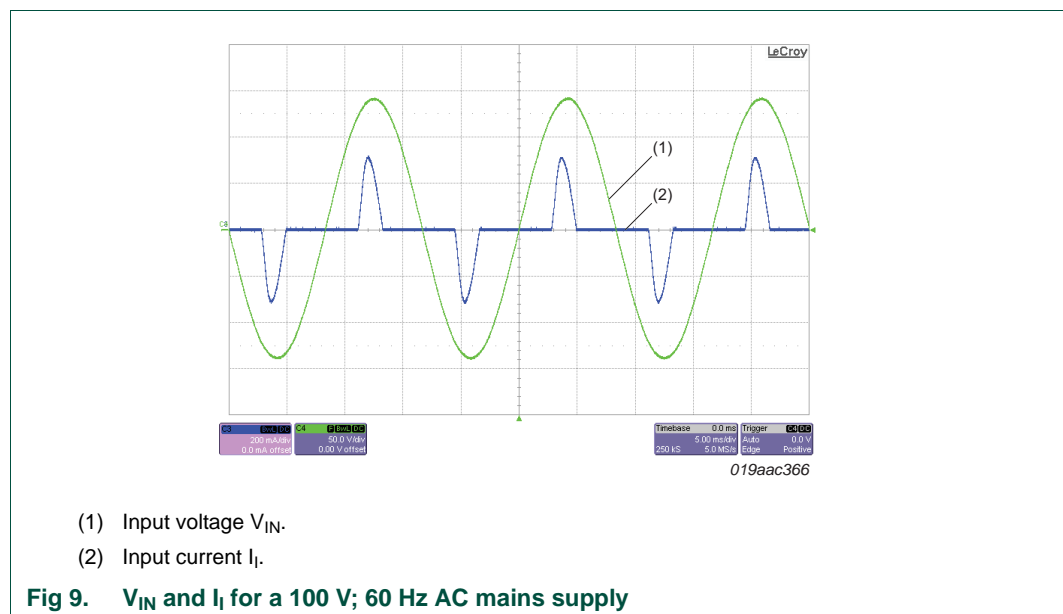

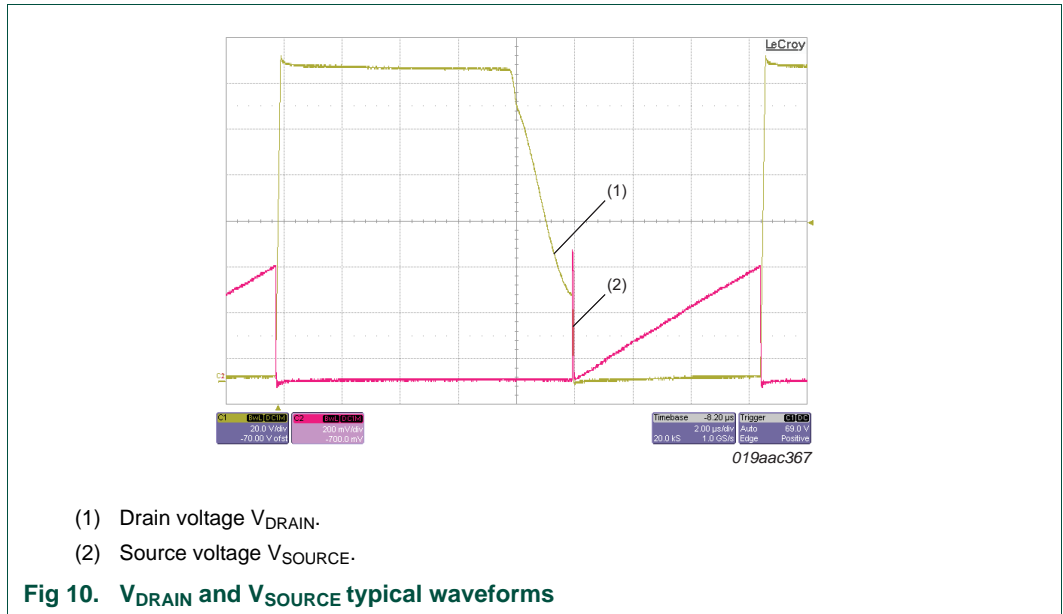

5. Connection data

The evaluation board operates from either:

- SSL21081 and SSL21082: 100 V (AC) to 120 V (AC) mains supply voltage
- SSL21083 and SSL21084: 230 V (AC) mains supply voltage

The evaluation board is designed to work with an LED module with an operating voltage of:

- SSL21081 and SSL21082: 60 V
- SSL21083 and SSL21084: 120 V

Loads consisting of multiple high-power LEDs in series with similar operating voltages can also be used. A dedicated SHARP GW5BDQ27KK3 LED load for connecting to connector K2A is available on request. Other loads can be connected to either connector K2A or K3.

When attaching an LED load to a board under power (hot plugging), an inrush peak current occurs due to discharge of capacitor C3. After several discharges, the LEDs will deteriorate or become damaged.

Jumper settings J1A to J6A shown in [Table 4](#) set the package-specific circuitry to enable each device to function correctly.

Table 4. SSL2108X jumper settings overview

IC	Package	Jumper settings					
		J1A	J2A	J3A	J4A	J5A	J6A
SSL21081	SO8	no	yes	no	yes	no	yes
SSL21083							
SSL21082	SO12	yes	no	yes	no	yes	no
SSL21084							

5.1 The board connections

When connecting the evaluation board consider the following:

- Place a galvanic isolated transformer between the AC source and the evaluation board connector K1A, if used.
- Connect a user-defined LED module to connector K2A or K3. Ensure that the anode of the LED module is connected to one of the positive LED terminals.
- Connector K4 can be used:
 - to connect an external NTC resistance. Remove the pre-soldered NTC RT1 (see [Ref. 1](#))
 - to use a PWM dimming signal to the converter (see [Ref. 1](#))

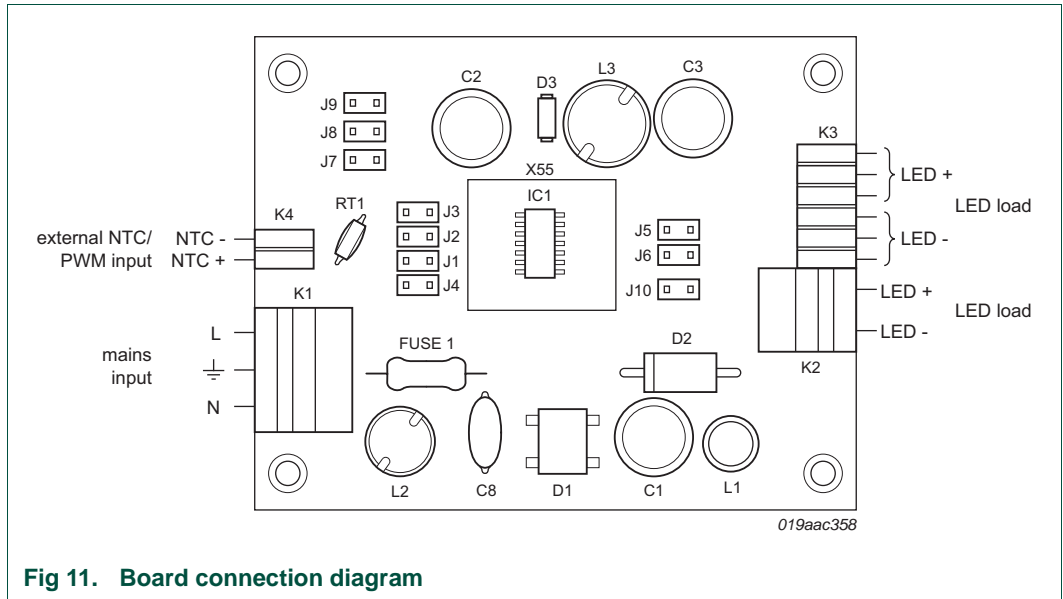

Fig 11. Board connection diagram

6. Functional description

The SSL2108X IC ([Ref. 1](#)) uses Boundary Conduction Mode (BCM) with peak current control. The SSL2108X controls and drives the converter. In addition, the SSL2108X offers a low component count LED buck converter solution. Valley switching and PWM dimming are implemented into the SSL2108X together with several protection features:

- UnderVoltage LockOut (UVLO)
- Leading-Edge Blanking (LEB)
- OverCurrent Protection (OCP)
- Internal OverTemperature Protection (OTP)
- Brownout protection
- Short-Winding Protection (SWP)
- Output Short Protection (OSP)
- NTC over temperature control and protection

Both the SWP and the OSP are latched protection circuits. These protective features cause the IC to halt until a reset is executed. If V_{CC} drops below its restart level, the IC resets the latched protection mode. Restarting the evaluation board is done by removing AC mains supply voltage. All other protective features cause a safe restart of the converter. Refer to the *SSL2108X data sheet* for detailed information on all protective features.

Depending on the selected SSL2108X version, the evaluation board is optimized for an LED voltage, LED current and resulting output power. See [Table 2](#). As a default, jumper J7A is set to apply the full output power to the LED load. Setting jumper J8A or J9A instead reduces the output power to either 66 % or 33 % of the original output power.

Remark: Do not remove or set jumpers when the board is connected to the AC mains supply voltage because LED damage can occur.

Jumper J10A is connected in series with the brownout capacitor C8. Removing this jumper sets the brownout protection trigger values to be reset to default value.

Remark: Brownout protection is only available in the SSL21082 and SSL21084.

TVS Diode D2 is present to protect the DC circuit against overvoltage.

7. Board optimization

The EMC filter calculations for components C1, C2, L1 are described in AN11041 (see Ref. 2). On the evaluation board, L2 and C8 have been added to provide extra filtering to meet EMC norms.

Power factor of the evaluation board depends mainly on the input resistance of the input fused resistor FUS1. A higher resistance proportionally increases the power factor but reduces the overall efficiency of the evaluation board.

Another way to get higher power factor is to add a valley fill circuit. The valley fill circuit improves power factor with reduced efficiency losses. The disadvantage is the higher component count needed. Figure 12 gives an overview for the SSL21081 of input resistance as a function of power factor and efficiency.

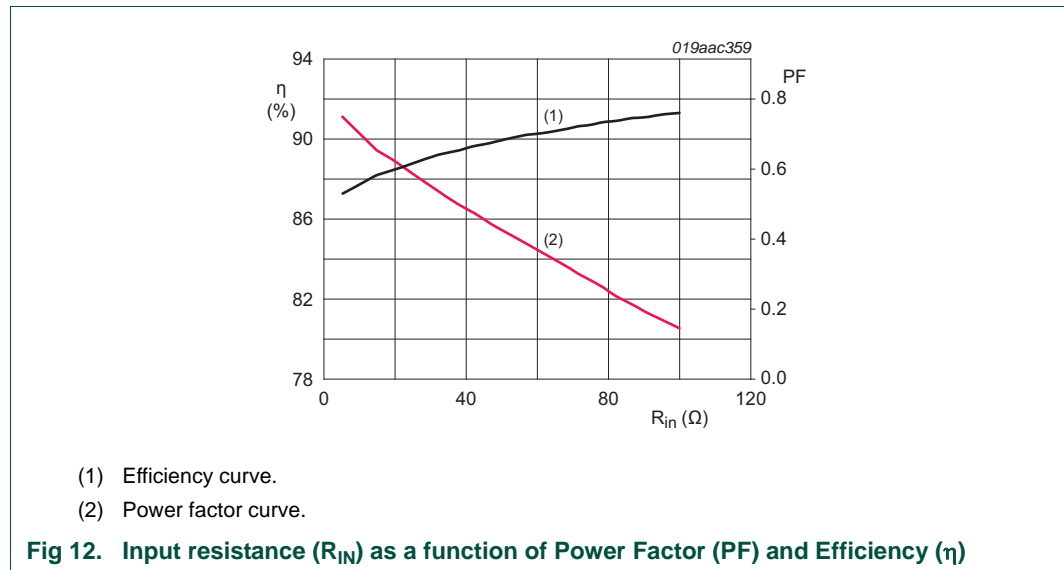

Remark: Calculations for other components on the SSL2108X evaluation board can be found in AN11041 (see Ref. 2).

7.1 Active bypass

An increased value for the inrush current resistor causes the board to operate with the most phase cut dimmers, but also lowers the efficiency. If a higher power factor is not required, but leading-edge dimmer compatibility and high efficiency are important, the active bypass option is available. In this circuit, the inrush current resistor is bypassed using an SCR (see [Figure 13](#)).

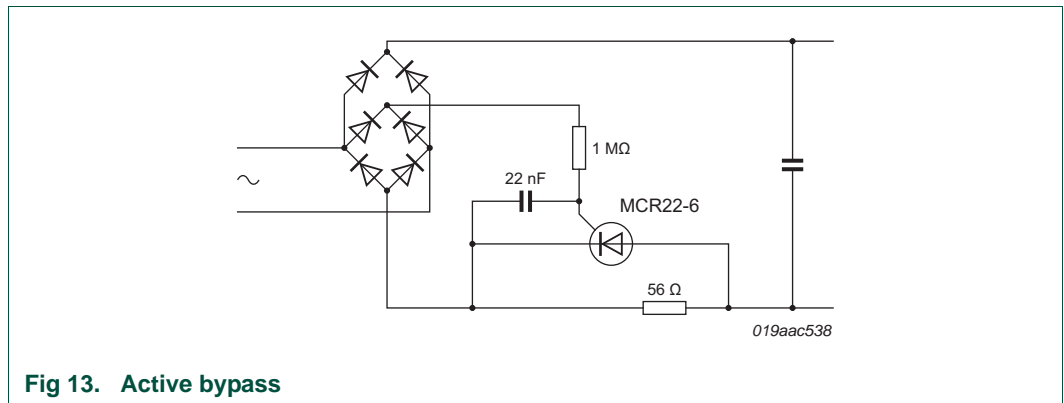

Fig 13. Active bypass

8. Negative Temperature Coefficient (NTC) function

The NTC pin can act as a control for thermal protection, an input for disabling/enabling the light output using PWM dimming and a soft-start function.

When using the NTC pin as a control for thermal protection, the pre-soldered NTC RT1 can be used. Alternatively, a user-defined NTC resistor can be directly connected to this pin through connector K4. Remove the pre-soldered NTC RT1 in this case. If necessary, a resistor R6 can be mounted to fine-tune the NTC protection. As the default, a 0 Ω resistance is mounted.

In addition, a PWM signal can be connected to connector K4, making PWM dimming possible. Capacitor C7 is used as the soft-start capacitor. When using the soft-start capacitor, the NTC protection function changes from auto-restart protection to a latched protection.

Remark: Detailed information on the NTC function can be found in the *SSL2108X data sheet* (see [Ref. 1](#)).

9. Schematic

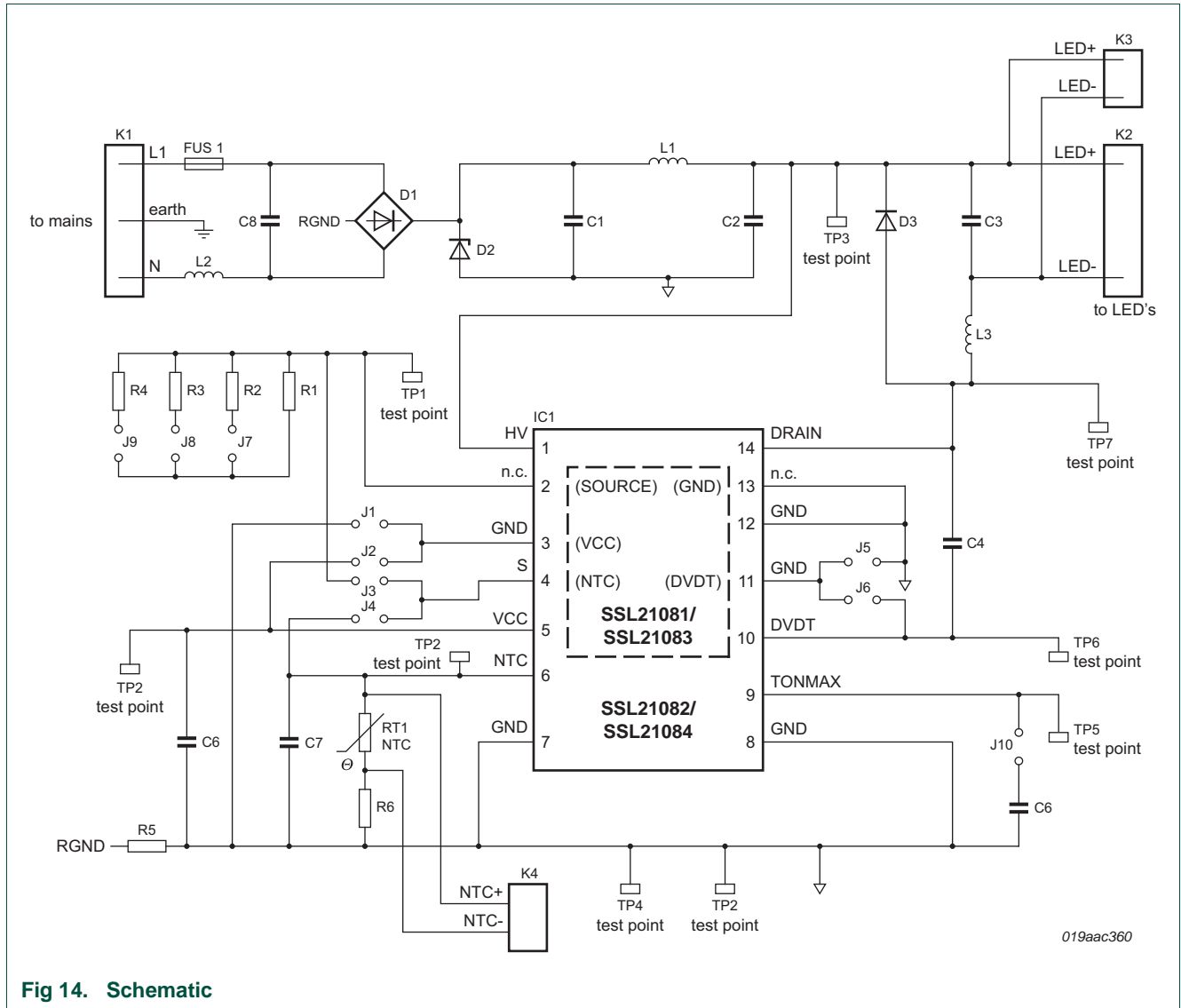

Fig 14. Schematic

10. Bill of materials (BOM)

10.1 BOM for SSL21081 evaluation board

Table 5. SSL21081 Bill of materials

Ref.	Description and value	Manufacturer and part no.	Remark
A1	SSL21081 controller IC	NXP Semiconductors	-
A1A	IC socket	Wells-cti; 652B0142211-002	not mounted
C1	filter capacitor; 10 μ F; 200 V	Nichicon; UVZ2D100MPD1TD	-
C2	filter capacitor; 10 μ F; 200 V	Nichicon; UVZ2D100MPD1TD	-
C3	ripple capacitor; 2.2 μ F; 450 V	Panasonic; ECA2WHG2R2	-
C4	dV/dt capacitor; 2 kV; 150 pF	Multicomp; MCCA000740	-
C5	VCC supply; capacitor; 10 μ F; 25 V	Murata; GRM21BR61E106KA73L	-
C6	$t_{on(max)}$ capacitor	-	not mounted
C7	soft-start/ripple filter; 22 μ F; 10 V	Kemet; C1206C226M8PACTU	-
C8	filter capacitor	-	not mounted
D1	bridge rectifier; 1 A; 600 V	Multicomp; DBLS105G	-
D2	TVS; 200 V; 1.5 kW	ST Microelectronics; 1.5KE 200A	-
D3	ES1J; 1 A; 600 V	Multicomp; ES1J	-
Fus 1	fused resistor; 2 W; 10 R	Welwyn; EMC2-10RK	-
J1 to J9	headers	Fischer Elektronik; MK 05/50G	-
J10	header	Fischer Elektronik; MK 05/50G	not mounted
J1A	jumper	Lumberg; 2,54MKB	not mounted
J2A	jumper	Lumberg; 2,54MKB	-
J3A	jumper	Lumberg; 2,54MKB	not mounted
J4A	jumper	Lumberg; 2,54MKB	-
J5A	jumper	Lumberg; 2,54MKB	not mounted
J6A	jumper	Lumberg; 2,54MKB	-
J7A	jumper	Lumberg; 2,54MKB	-
J8A	jumper	Lumberg; 2,54MKB	not mounted
J9A	jumper	Lumberg; 2,54MKB	not mounted
J10A	jumper	Lumberg; 2,54MKB	not mounted
K1	header	Weidmuller; SL 5.08/3/90	-
K1A	socket	Weidmuller; BL 5.08/3	-
K2	header	Weidmuller; SL 5.08/2/90	-
K2A	socket	Weidmuller; BL 5.08/2	-
K3	header	Fischer Elektronik; BL3.36Z	-
K4	header	Fischer Elektronik; BL3.36Z	-
L1	filter inductor; 1 mH; 170 mA	Murata power solutions; 22R105C	-
L2	filter inductor; Short	-	-
L3	buck inductor; 1 mH; 0.5 A	Wurth elektronik; 768772102	-
R1	R_{sense} ; 6.8 Ω ; 0.33 W; 1 %	Panasonic; ERJ8BQF6R8V	-
R2	R_{sense} ; 3.3 Ω ; 0.33 W; 1 %	Panasonic; ERJ8BQF3R3V	-

Table 5. SSL21081 Bill of materials ...continued

Ref.	Description and value	Manufacturer and part no.	Remark
R3	R _{sense} ; 5.1 Ω; 0.25 W; 1 %	Vishay daile; CRCW12065R10FKEA	-
R4	R _{sense} ; 16 Ω; 0.25 W; 1 %	Vishay daile; CRCW120616R0FKEA	-
R5	inrush resistor; 0 Ω	Multicomp; MC 0.1W 0805 0R	-
R6	resistor; 0 Ω	Multicomp; MC 0.1W 0805 0R	-
RT1	NTC; 100 kΩ	EPCOS; B57164K104J	-
TP1 to TP8	test pins	Vero; 20-313138	-
X56	jumper link	Fischer Elektronik; 2412 015 30123	-
X57	jumper link;	Fischer Elektronik; 2412 015 30123	-

10.2 BOM for SSL21082 evaluation board

Table 6. SSL21082 Bill of materials

Ref.	Description and value	Manufacturer and part no.	Remark
A1	SSL21082 Controller IC	NXP Semiconductors; SSL21082T	-
A1A	IC Socket; n.m.	Wells-cti; 652B0142211-002	not mounted
C1	filter capacitor; 10 μF; 200 V	Nichicon; UVZ2D100MPD1TD	-
C2	filter capacitor; 10 μF; 200 V	Nichicon; UVZ2D100MPD1TD	-
C3	ripple capacitor; 2.2 μF; 450 V	Panasonic; ECA2WHG2R2	-
C4	dV/dt capacitor; 150 pF; 2000 V	Multicomp; MCCA000740	-
C5	VCC supply capacitor; 10 μF; 25 V	MURATA; GRM21BR61E106KA73L	-
C6	t _{on(max)} capacitor; 100 pF; 100 V	AVX; 08051A101JAT2A	-
C7	soft-start/ripple filter; 22 μF; 10 V	KEMET; C1206C226M8PACTU	-
C8	filter capacitor; n.m.	-	not mounted
D1	bridge rectifier; 1 A; 600 V	Multicomp; DBLS105G	-
D2	TVS; 200 V; 1.5 kW	ST Microelectronics; 1.5KE200A	-
D3	ES1J; 1 A; 600 V	Multicomp; ES1J	-
Fus 1	fused resistor; 2 W; 10 Ω	Welwyn; EMC2-10RK	-
J1 to J9	headers	Fischer Elektronik; MK 05/50G	-
J10	header	Fischer Elektronik; MK 05/50G	-
J1A	jumper	Lumberg; 2,54MKB	-
J2A	jumper; n.m.	Lumberg; 2,54MKB	not mounted
J3A	jumper	Lumberg; 2,54MKB	-
J4A	jumper; n.m.	Lumberg; 2,54MKB	not mounted
J5A	jumper	Lumberg; 2,54MKB	-
J6'	jumper; n.m.	Lumberg; 2,54MKB	not mounted
J7A	jumper	Lumberg; 2,54MKB	-
J8A	jumper; n.m.	Lumberg; 2,54MKB	not mounted
J9A	jumper; n.m.	Lumberg; 2,54MKB	not mounted
J10A	jumper	Lumberg; 2,54MKB	-
K1	header	Weidmuller; SL 5.08/3/90	-
K1A	socket	Weidmuller; BL 5.08/3	-
K2	header	Weidmuller; SL 5.08/2/90	-

Table 6. SSL21082 Bill of materials ...continued

Ref.	Description and value	Manufacturer and part no.	Remark
K2A	socket	Weidmuller; BL 5.08/2	-
K3	header	Fischer Elektronik; BL3.36Z	-
K4	header	Fischer Elektronik; BL3.36Z	-
L1	filter inductor; 1 mH; 170 mA	Murata power solutions; 22R105C	-
L2	filter inductor; short	-	-
L3	buck inductor; 680 μ H; 0.35 A	Panasonic; ELC09D681F	-
R1	R _{sense} ; 0.33 W; 1 %; 6.8 Ω	Panasonic; ERJ8BQF6R8V	-
R2	R _{sense} ; 0.33 W; 1 %; 1.6 Ω	Panasonic; ERJ8BQF1R6V	-
R3	R _{sense} ; 0.25 W; 1 %; 2.2 Ω	Panasonic; ERJ8BQF2R2V	-
R4	R _{sense} ; 0.25 W; 1 %; 2.7 Ω	Panasonic; ERJ8BQF2R7V	-
R5	inrush resistor; 0 Ω	Multicomp; MC 0.1 W 0805 0 R	-
R6	resistor; 0 Ω	Multicomp; MC 0.1 W 0805 0 R	-
RT1	NTC; 100 k Ω	EPCOS; B57164K104J	-
TP1 to TP8	test pins	Vero; 20-313138	-
X56	jumper link	Fischer Elektronik; 2412 015 30123	-
X57	jumper link	Fischer Elektronik; 2412 015 30123	-

10.3 BOM for SSL21083 evaluation board

Table 7. SSL21083 Bill of materials

Ref.	Description and value	Manufacturer and part no.	Remark
A1	SSL21083 Controller IC	NXP Semiconductors; SSL21083	-
A1A	IC Socket; n.m.	Wells-cti; 652B0142211-002	not mounted
C1	filter capacitor; 4.7 μ F; 400 V	Panasonic; ECA2GHG4R7	-
C2	filter capacitor; 4.7 μ F; 400 V	Panasonic; ECA2GHG4R7	-
C3	ripple capacitor; 3.3 μ F; 400 V	Panasonic; ECA2GHG3R3	-
C4	dV/dt capacitor; 100 pF; 1000 V	Johanson Dielectrics; 102R18W101KV4E	-
C5	VCC supply capacitor; 10 μ F; 25 V	Murata; GRM21BR61E106KA73L	-
C6	t _{on(max)} capacitor; n.m.	-	-
C7	soft-start/ripple filter; 22 μ F 10 V	KEMET; C1206C226M8PACTU	-
C8	filter capacitor; n.m.	-	not mounted
D1	bridge rectifier; 1 A; 600 V	Multicomp; DBLS105G	-
D2	TVS; 400 V; 1.5 kW	ST Microelectronics; 1.5KE400A	-
D3	ES1J; 1 A; 600 V	Multicomp; ES1J	-
Fus 1	fused resistor; 2 W; 22 Ω	Welwyn; EMC2-22RK1	-
J1-J9	headers	Fischer elektronik; MK 05/50G	-
J10	header; n.m.	Fischer Elektronik; MK 05/50G	not mounted
J1A	jumper; n.m.	Lumberg; 2,54MKB	not mounted
J2A	jumper	Lumberg; 2,54MKB	-
J3A	jumper; n.m.	Lumberg; 2,54MKB	not mounted
J4A	jumper	Lumberg; 2,54MKB	-

Table 7. SSL21083 Bill of materials ...continued

Ref.	Description and value	Manufacturer and part no.	Remark
J5A	jumper; n.m.	Lumberg; 2,54MKB	not mounted
J6A	jumper	Lumberg; 2,54MKB	-
J7A	jumper	Lumberg; 2,54MKB	-
J8A	jumper; n.m.	Lumberg; 2,54MKB	not mounted
J9A	jumper; n.m.	Lumberg; 2,54MKB	not mounted
J10A	jumper; n.m.	Lumberg; 2,54MKB	not mounted
K1	header	Weidmuller; SL 5.08/3/90	-
K1A	socket	Weidmuller; BL 5.08/3	-
K2	header	Weidmuller; SL 5.08/2/90	-
K2A	socket	Weidmuller; BL 5.08/2	-
K3	header	Fischer Elektronik; BL3.36Z	-
K4	header	Fischer Elektronik; BL3.36Z	-
L1	filter inductor; 1 mH; 170 mA	Murata power solutions; 22R105C	-
L2	filter inductor; wire	-	-
L3	buck inductor; 3.3 mH; 100 mA	Murata power solutions; 22R335C	-
R1	R _{sense} ; 0.125 W; 1 %; 20 Ω	Multicomp; MC 0.125W 1206 1% 20R	-
R2	R _{sense} ; 0.33 W; 5 %; 4.3 Ω	Panasonic; ERJ8BQF4R3V	-
R3	R _{sense} ; 0.33 W; 1 %; 6.8 Ω	Panasonic; ERJ8BQF6R8V	-
R4	R _{sense} ; 0.33 W; 5 %; 18 Ω	Panasonic; ERJT08J180V	-
R5	inrush resistor; 0 Ω	Multicomp; MC 0.1W 0805 0R	-
R6	resistor; 0 Ω	Multicomp; MC 0.1W 0805 0R	-
RT1	NTC; 100 kΩ	EPCOS; B57164K104J	-
TP1-TP8	test pins	Vero; 20-313138	-
X56	jumper link	Fischer Elektronik; 2412 015 30123	-
X57	jumper link	Fischer Elektronik; 2412 015 30123	-

10.4 BOM for SSL21084 evaluation board

Table 8. SSL21084 Bill of materials

Ref.	Description and value	Manufacturer and part no.	Remark
A1	SSL21084 Controller IC	NXP Semiconductors; SSL21084T	-
A1A	IC Socket; n.m.	Wells-cti; 652B0142211-002	not mounted
C1	filter capacitor; 4.7 μ F; 400 V	Panasonic; ECA2GHG4R7	-
C2	filter capacitor; 4.7 μ F; 400 V	Panasonic; ECA2GHG4R7	-
C3	ripple capacitor; 3.3 μ F; 400 V	Panasonic; ECA2GHG3R3	-
C4	dV/dt capacitor; 100 pF; 1000 V	Johanson Dielectrics; 102R18W101KV4E	-
C5	VCC supply capacitor; 10 μ F; 25 V	Murata; GRM21BR61E106KA73L	-
C6	$t_{on(max)}$ capacitor; 100 pF; 100 V	AVX; 08051A101JAT2A	-
C7	soft-start/ripple filter; 22 μ F; 10 V	KEMET; C1206C226M8PACTU	-
C8	filter capacitor; n.m.	-	not mounted
D1	bridge rectifier; 1 A; 600 V	Multicomp; DBLS105G	-
D2	TVS; 400 V; 1.5 kW	ST Microelectronics; 1.5KE400A	-
D3	ES1J; 1 A; 600 V	Multicomp; ES1J	-
Fus 1	fused resistor; 2 W; 22 Ω	Welwyn; EMC2-22RKI	-
J1-J9	headers	Fischer Elektronik; MK 05/50G	-
J10	header; n.m.	Fischer Elektronik; MK 05/50G	not mounted
J1A	jumper; n.m.	Lumberg; 2,54MKB	not mounted
J2A	jumper	Lumberg; 2,54MKB	-
J3A	jumper; n.m.	Lumberg; 2,54MKB	not mounted
J4A	jumper	Lumberg; 2,54MKB	-
J5A	jumper; n.m.	Lumberg; 2,54MKB	not mounted
J6A	jumper	Lumberg; 2,54MKB	-
J7A	jumper	Lumberg; 2,54MKB	-
J8A	jumper; n.m.	Lumberg; 2,54MKB	not mounted
J9A	jumper; n.m.	Lumberg; 2,54MKB	not mounted
J10A	jumper; n.m.	Lumberg; 2,54MKB	not mounted
K1	header	Weidmuller; SL 5.08/3/90	-
K1A	socket	Weidmuller; BL 5.08/3	-
K2	header	Weidmuller; SL 5.08/2/90	-
K2A	socket	Weidmuller; BL 5.08/2	-
K3	header	Fischer Elektronik; BL3.36Z	-
K4	header	Fischer Elektronik; BL3.36Z	-
L1	filter inductor; 1 mH; 170 mA	Murata power solutions; 22R105C	-
L2	filter inductor; wire	-	-
L3	buck inductor; 3.3 mH; 100 mA	Murata power solutions; 22R335C	-
R1	R_{sense} ; 0.33 W; 1 %, 6.2 Ω	Panasonic; ERJ8RQF6R2V	-
R2	R_{sense} ; 0.25 W; 1 %, 3.6 Ω	Panasonic; ERJ8RQF3R6V	-
R3	R_{sense} ; 0.33 W; 1 %, 5.1 Ω	Panasonic; ERJ8BQF5R1V	-
R4	R_{sense} ; 0.33 W; 1 %, 8.2 Ω	Panasonic; ERJ8BQF8R2V	-

Table 8. SSL21084 Bill of materials ...continued

Ref.	Description and value	Manufacturer and part no.	Remark
R5	inrush resistor; 0 Ω	Multicomp; MC 0.1W 0805 0R	-
R6	resistor; 0 Ω	Multicomp; MC 0.1W 0805 0R	-
RT1	NTC; 100 k Ω	EPCOS; B57164K104J	-
TP1-TP8	test pins	Vero; 20-313138	-
X56	jumper link	Fischer Elektronik; 2412 015 30123	-
X57	jumper link	Fischer Elektronik; 2412 015 30123	-

11. Printed-Circuit Board (PCB) data

11.1 Evaluation board photographs

Remark: The configuration of the SSL21083 is similar to the SSL21081 although BOM is different. The same is true of the SSL21084 when compared to the SSL21082.

The evaluation board shown in [Figure 15](#) is a large format footprint. Its size enables the full functionality of the SSL2108X IC family to be highlighted. The measurement pins, connectors and other components are used to allow any one of the SSL2108X ICs to be dropped in to place.

[Figure 16](#) shows the SSL21081 reference board which can be used in retrofit lamp designs. It is clear that the total form factor is reduced using the SSL2108X ICs in a real-world application. A PCB size reduction and thus an efficiency of more than 92 % can be reached.

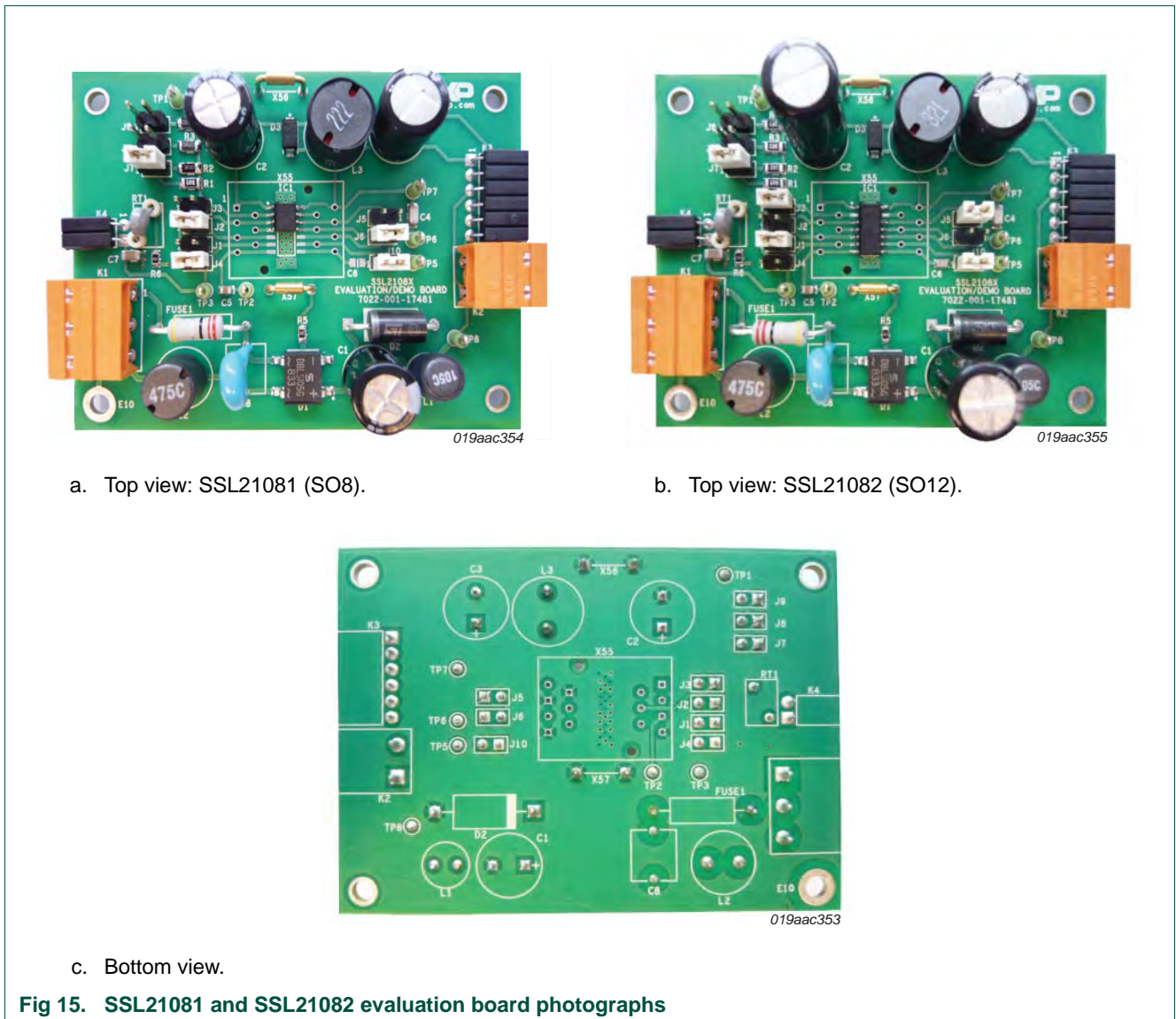

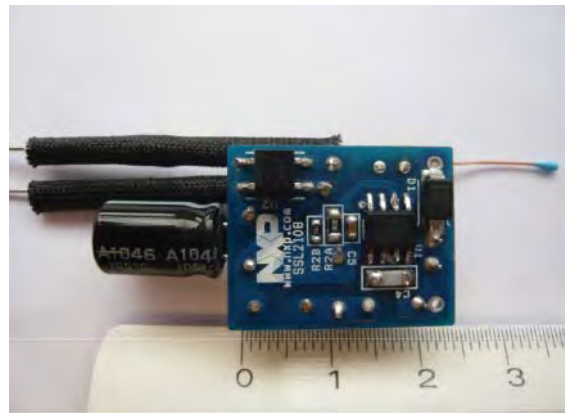

019aac357

a. Top view: SSL21081 (SO8) reference board.

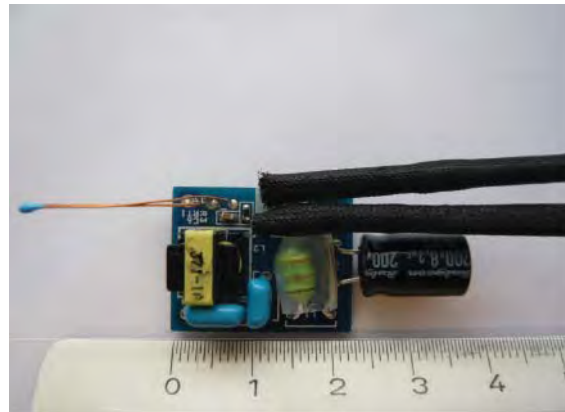

019aac356

b. Top view: SSL21082 (SO12) reference board.

Fig 16. SSL21081 and SSL21082 reference board photographs

12. Abbreviations

Table 9. Abbreviations

Acronym	Description
BCM	Boundary Conduction Mode
CCM	Continuous Conduction Mode
DCM	Discontinuous Conduction Mode
EMC	ElectroMagnetic Compatibility
EMI	ElectroMagnetic Interference
LED	Light Emitting Diode
MOSFET	Metal-Oxide Semiconductor Field-Effect Transistor
OCP	OverCurrent Protection
OSP	Output Short Protection
OTP	OverTemperature Protection
PCB	Printed-Circuit Board
PWM	Pulse-Width Modulation
SSL	Solid-State Lighting
SWP	Short-Winding Protection
UVLO	UnderVoltage LockOut

13. References

- [1] **SSL2108X** — SSL2108X driver data sheet.
- [2] **AN11041** — SSL2108X driver for SSL applications.
- [3] **AN10876** — Buck converter for SSL applications.

14. Legal information

14.1 Definitions

Draft — The document is a draft version only. The content is still under internal review and subject to formal approval, which may result in modifications or additions. NXP Semiconductors does not give any representations or warranties as to the accuracy or completeness of information included herein and shall have no liability for the consequences of use of such information.

14.2 Disclaimers

Limited warranty and liability — Information in this document is believed to be accurate and reliable. However, NXP Semiconductors does not give any representations or warranties, expressed or implied, as to the accuracy or completeness of such information and shall have no liability for the consequences of use of such information.

In no event shall NXP Semiconductors be liable for any indirect, incidental, punitive, special or consequential damages (including - without limitation - lost profits, lost savings, business interruption, costs related to the removal or replacement of any products or rework charges) whether or not such damages are based on tort (including negligence), warranty, breach of contract or any other legal theory.

Notwithstanding any damages that customer might incur for any reason whatsoever, NXP Semiconductors' aggregate and cumulative liability towards customer for the products described herein shall be limited in accordance with the *Terms and conditions of commercial sale* of NXP Semiconductors.

Right to make changes — NXP Semiconductors reserves the right to make changes to information published in this document, including without limitation specifications and product descriptions, at any time and without notice. This document supersedes and replaces all information supplied prior to the publication hereof.

Suitability for use — NXP Semiconductors products are not designed, authorized or warranted to be suitable for use in life support, life-critical or safety-critical systems or equipment, nor in applications where failure or malfunction of an NXP Semiconductors product can reasonably be expected to result in personal injury, death or severe property or environmental damage. NXP Semiconductors accepts no liability for inclusion and/or use of NXP Semiconductors products in such equipment or applications and therefore such inclusion and/or use is at the customer's own risk.

Applications — Applications that are described herein for any of these products are for illustrative purposes only. NXP Semiconductors makes no representation or warranty that such applications will be suitable for the specified use without further testing or modification.

Customers are responsible for the design and operation of their applications and products using NXP Semiconductors products, and NXP Semiconductors accepts no liability for any assistance with applications or customer product

design. It is customer's sole responsibility to determine whether the NXP Semiconductors product is suitable and fit for the customer's applications and products planned, as well as for the planned application and use of customer's third party customer(s). Customers should provide appropriate design and operating safeguards to minimize the risks associated with their applications and products.

NXP Semiconductors does not accept any liability related to any default, damage, costs or problem which is based on any weakness or default in the customer's applications or products, or the application or use by customer's third party customer(s). Customer is responsible for doing all necessary testing for the customer's applications and products using NXP Semiconductors products in order to avoid a default of the applications and the products or of the application or use by customer's third party customer(s). NXP does not accept any liability in this respect.

Export control — This document as well as the item(s) described herein may be subject to export control regulations. Export might require a prior authorization from national authorities.

Evaluation products — This product is provided on an "as is" and "with all faults" basis for evaluation purposes only. NXP Semiconductors, its affiliates and their suppliers expressly disclaim all warranties, whether express, implied or statutory, including but not limited to the implied warranties of non-infringement, merchantability and fitness for a particular purpose. The entire risk as to the quality, or arising out of the use or performance, of this product remains with customer.

In no event shall NXP Semiconductors, its affiliates or their suppliers be liable to customer for any special, indirect, consequential, punitive or incidental damages (including without limitation damages for loss of business, business interruption, loss of use, loss of data or information, and the like) arising out of the use of or inability to use the product, whether or not based on tort (including negligence), strict liability, breach of contract, breach of warranty or any other theory, even if advised of the possibility of such damages.

Notwithstanding any damages that customer might incur for any reason whatsoever (including without limitation, all damages referenced above and all direct or general damages), the entire liability of NXP Semiconductors, its affiliates and their suppliers and customer's exclusive remedy for all of the foregoing shall be limited to actual damages incurred by customer based on reasonable reliance up to the greater of the amount actually paid by customer for the product or five dollars (US\$5.00). The foregoing limitations, exclusions and disclaimers shall apply to the maximum extent permitted by applicable law, even if any remedy fails of its essential purpose.

14.3 Trademarks

Notice: All referenced brands, product names, service names and trademarks are the property of their respective owners.

15. Contents

1	Introduction	3
2	Safety warning	4
3	Specification	4
4	Performance data	5
4.1	Output load	5
4.2	Efficiency Curve	5
4.3	Input voltage dependency	6
4.4	ElectroMagnetic Compatibility data	6
4.5	SSL21081 mains harmonics	9
5	Connection data	11
5.1	The board connections	11
6	Functional description	12
7	Board optimization	13
7.1	Active bypass	14
8	Negative Temperature Coefficient (NTC) function	15
9	Schematic	16
10	Bill of materials (BOM)	17
10.1	BOM for SSL21081 evaluation board	17
10.2	BOM for SSL21082 evaluation board	18
10.3	BOM for SSL21083 evaluation board	19
10.4	BOM for SSL21084 evaluation board	21
11	Printed-Circuit Board (PCB) data	23
11.1	Evaluation board photographs	23
12	Abbreviations	25
13	References	25
14	Legal information	26
14.1	Definitions	26
14.2	Disclaimers	26
14.3	Trademarks	26
15	Contents	27

Please be aware that important notices concerning this document and the product(s) described herein, have been included in section 'Legal information'.

© NXP B.V. 2011.

All rights reserved.

For more information, please visit: <http://www.nxp.com>

For sales office addresses, please send an email to: salesaddresses@nxp.com

Date of release: 30 August 2011

Document identifier: UM10468